

**prefabricados**

---

**tarifa 2025**

**soriguē**



## **Pavimentos**

P 4 — 10



## **Urbanización**

P 11 — 28



## **Saneamiento**

P 29 — 35

## Pavimentos

P 4 — 10

Losa Connecta	5
Adoquín Vía Verde	6
Adoquín Vía Índalo	6
Adoquín Vía Aldana	6
Adoquín Betulo	7
Adoquín Serie MAX	8
Adoquín Serie Geométrica	8
Adoquín Top Urban	8
Serie Dc	9
Serie Mix	9
Serie Pétreo	9
Serie Basic	10

## Urbanización

P 11 — 28

Bordillos serie T	12
Bordillos tipo americano	12
Bordillos remontables	13
Bordillos jardín	13
Bordillos alcorques	14
Rigola	14
Bordillos especiales ICA	15
Imbornal	16
Escuadras	17
Curvas	19
Peldaños	20
Vados	21
Pasos peatonales elevados	28
Acabados especiales	28

## Saneamiento

P 29 — 35

Pozos de registro de hormigón y armado	30
Conos HA	30
Anillos HA	31
Tapas para pozos HA	31
Bajantes y cunetas	32
Arquetas	33
Tapas e imbornales	33
Pozos de hormigón en masa	34
Barreras New Jersey	34
Tubos vibro prensados de hormigón en masa	35

## Condiciones generales

P 36

**Edición: Enero 2025**

Sorigué se reserva el derecho de modificar cualquier precio, información técnica o de producto sin previo aviso.

[sorigue.com](http://sorigue.com)

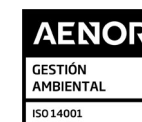

soriguē

# Pavimentos

Con más de seis décadas de experiencia en el desarrollo de pavimentos innovadores, Sorigué ofrece productos a medida adaptados a cada cliente.

Entre sus pavimentos destacan las losas, los peldaños, los bordillos, pero especialmente una gran tipología de adoquines, que se ofrecen en una amplia gama de colores y con diversas soluciones sostenibles para cada necesidad.

# Losa Connecta

## Cuadrada



TRÁFICO  
LIGERO



TRÁFICO  
PEATONAL



# Losa Connecta

## Rectangular



TRÁFICO  
LIGERO



TRÁFICO  
PEATONAL



### con bisel

Dimensiones	M <sup>2</sup> Palet	Peso Kg/m <sup>2</sup>	Precio m <sup>2</sup>		
			Gris	Color	
				Dc	Mix
20 × 20 × 7 cm	7,68	164	27,20€	38,70€	40,70€
40 × 40 × 7 cm	9,60	164	27,20€	38,70€	40,70€
50 × 50 × 7 cm	8,00	164	27,20€	38,70€	40,70€

### sin bisel

Dimensiones	M <sup>2</sup> Palet	Peso Kg/m <sup>2</sup>	Precio m <sup>2</sup>		
			Gris	Color	
				Dc	Mix
20 × 20 × 7 cm	7,68	164	27,20€	38,70€	40,70€
30 × 30 × 8 cm	8,64	186	29,60€	41,15€	42,50€
40 × 40 × 7 cm	7,68	164	27,20€	38,70€	40,70€
40 × 40 × 7 cm Sensitive	7,68	164	30,50€	39,70€	44,50€
50 × 50 × 5,5 cm	10,00	129	24,75€	32,85€	35,15€
50 × 50 × 7 cm	8,00	164	27,20€	38,70€	40,70€

### con bisel

Dimensiones	M <sup>2</sup> Palet	Peso Kg/m <sup>2</sup>	Precio m <sup>2</sup>		
			Gris	Color	
				Dc	Mix
20 × 40 × 7 cm	9,60	164	27,20€	38,70€	40,70€
50 × 30 × 7 cm	7,20	164	27,20€	38,70€	40,70€
60 × 40 × 7 cm	7,68	164	27,20€	38,70€	40,70€

### sin bisel

Dimensiones	M <sup>2</sup> Palet	Peso Kg/m <sup>2</sup>	Precio m <sup>2</sup>		
			Gris	Color	
				Dc	Mix
20 × 40 × 7 cm	7,68	164	27,20€	38,70€	40,70€
60 × 40 × 5,5 cm	9,60	129	24,75€	32,85€	35,15€
60 × 40 × 7 cm	7,68	164	27,20€	38,70€	40,70€
60 × 40 × 8 cm	7,68	186	29,60€	41,15€	42,50€
60 × 40 × 10 cm	5,76	232	45,25€	52,75€	54,95€
80 × 60 × 12 cm	4,80	278	49,90€	55,60€	64,10€

\* Suplemento por manipulación palet incompleto 35€ / palet. - \* Cargo/abono palet: 19,35€ / ud. - \* Demérito palet, embalaje y flejado: 5,70€ / ud.

## Adoquín Vía verde



## Adoquín Vía Indalo



## Adoquín Vía Aldana

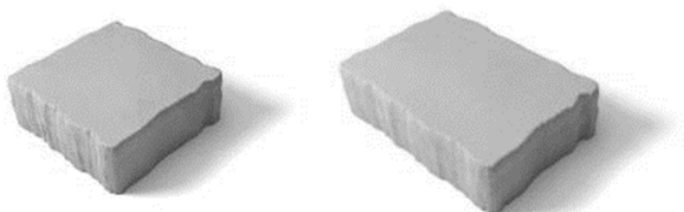

Dimensiones	M <sup>2</sup> Palet	Peso Kg/m <sup>2</sup>	Precio m <sup>2</sup>		
			Gris	Color	
				Dc	Mix
20 × 20 × 8 cm	7,68	132	35,50€	45,20€	47,90€
28 × 14 × 8 cm	7,53	132	35,50€	45,20€	47,90€



TRÁFICO LIGERO



TRÁFICO PEATONAL



Dimensiones	M <sup>2</sup> Palet	Peso Kg/m <sup>2</sup>	Precio m <sup>2</sup>		
			Gris	Color	
				Dc	Mix
12 × 16 × 8 cm	8,60	186	29,60€	41,15€	42,50€
16 × 16 × 8 cm	8,60	186	29,60€	41,15€	42,50€
24 × 16 × 8 cm	9,22	186	29,60€	41,15€	42,50€
Multi Bloque 20,8×20,8×17,3	90	15/ud	4€/ud	7€/ud	7€/ud
20 × 10 × 6 cm	10,80	140	26,50€	34,85€	37,00€
20 × 10 × 8 cm	8,64	186	29,60€	41,15€	42,50€
20,8 × 17,3 × 7 cm	7,68	164	27,20€	38,70€	40,70€
30 × 20 × 6 cm (BI)	9,60	140	26,50€	34,85€	37,00€



TRÁFICO LIGERO



TRÁFICO PEATONAL



Dimensiones	M <sup>2</sup> Palet	Peso Kg/m <sup>2</sup>	Precio m <sup>2</sup>	
			Gris	Color monocapa
			10 × 10 × 8 cm	5,76
12 × 16 × 8 cm	8,60	186	42,25€	46,90€
16 × 16 × 8 cm	8,60	186	42,25€	46,90€
24 × 16 × 8 cm	9,22	186	42,25€	46,90€
20 × 10 × 6 cm	9,60	140	36,00€	42,25€
20 × 10 × 8 cm	7,68	186	42,25€	46,90€
20,8 × 17,3 × 7 cm	8,64	164	40,15€	45,50€



TRÁFICO LIGERO



TRÁFICO PEATONAL



\* Suplemento por manipulación palet incompleto 35€ / palet. - \* Cargo/abono palet: 19,35€ / ud. - \* Demérito palet, embalaje y flejado: 5,70€ / ud.



# Adoquín Betulo



TRÁFICO  
LIGERO



TRÁFICO  
PEATONAL

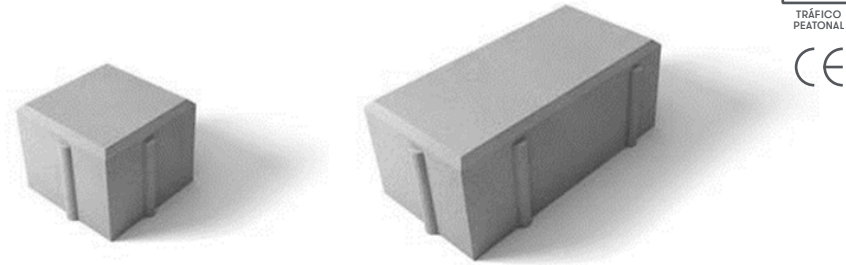

Dimensiones	M <sup>2</sup> Palet	Peso Kg/m <sup>2</sup>	Precio m <sup>2</sup>	
			Gris	Color Bicapa
10 × 10 × 8 cm	7,68	186	29,60€	41,15€
20 × 10 × 6 cm	9,60	140	26,50€	34,85€
20 × 10 × 8 cm	7,68	186	29,60€	41,15€

\* Suplemento por manipulación palet incompleto 35€ / palet. - \* Cargo/abono palet: 19,35€ / ud. - \* Demérito palet, embalaje y flejado: 5,70€ / ud.

# Adoquín Serie Max

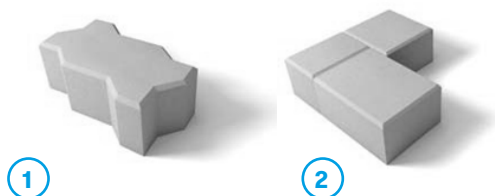

Dimensiones	M <sup>2</sup> Palet	Peso Kg/m <sup>2</sup>	Precio m <sup>2</sup>	
			Gris	Color Bicapa
Ica Max 6	10,40	140	30,90€	36,50€
<b>1</b> Ica Max 8	8,32	186	33,15€	38,25€
Ica Max 10	6,24	232	46,50€	51,90€
<b>2</b> Ica Optimax	8,40	186	32,75€	38,25€



TRÁFICO PESADO



# Adoquín Serie Geométrica



Dimensiones	M <sup>2</sup> Palet	Peso Kg/m <sup>2</sup>	Precio m <sup>2</sup>	
			Gris	Color Bicapa
<b>1</b> Trapezoidal	8,64	186	38,25€	46,80€
<b>2</b> Hexagonal	7,84	186	38,25€	46,80€
<b>3</b> Triangular	6,72	164	42,00€	51,90€



TRÁFICO PEATONAL



# Adoquín Top Urban

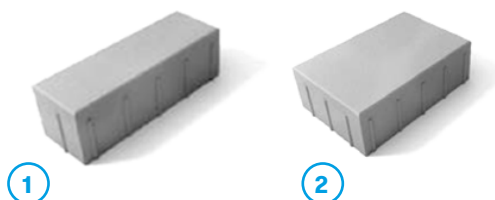

Dimensiones	M <sup>2</sup> Palet	Peso Kg/m <sup>2</sup>	Precio m <sup>2</sup>		
			Gris	Color	
				Dc	Mix
<b>1</b> 30 × 10 × 8 cm	6,48	186	29,60€	41,18€	42,50€
30 × 10 × 10 cm	5,76	232	46,20€	52,75€	54,95€
<b>2</b> 30 × 20 × 10 cm	5,76	232	46,20€	52,75€	54,95€



TRÁFICO PESADO



\* Suplemento por manipulación palet incompleto 35€ / palet. - \* Cargo/abono palet: 19,35€ / ud. - \* Demérito palet, embalaje y flejado: 5,70€ / ud.



## Serie Dc

BLANCO



BASALTO



GREEN



TEJA



TERRA



SIENA

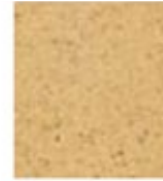

SALMON



## Serie Mix

TORMENTA



PLAYA



NILO



CAMEL



TERRACOTA



MONTAÑA



SEGUR



NATURE



ETNA



## Serie Pétreo

GRANITO ANTRACITA



GRANITO PARDO



GRANITO SIENA



GRANITO CREAM



GRANITO

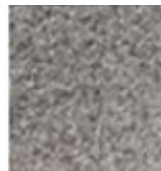

GRANITO PIRINEO



GRANITO PÓRFIDO



GRANITO NAKKAR



**Suplemento textura pétreo respecto color gris:**

Adoquines 14,00€/m<sup>2</sup>  
Placas connecta 17,00€/m<sup>2</sup>

\* Suplemento por manipulación palet incompleto 35€ / palet. - \* Cargo/abono palet: 19,35€ / ud. - \* Demérito palet, embalaje y flejado: 5,70€ / ud.



## Serie Basic

Dimensiones	M <sup>2</sup> Palet	Peso Kg/m <sup>2</sup>	Precio m <sup>2</sup>	
			Gris	Color
Panot 4 pastillas 20 x 20 x 4 cm	16,00	93	12,25€	17,50€
Super Panot 4 pastillas 20 x 20 x 8 cm	9,00	186	29,00€	42,50€
Panot 9 pastillas 20 x 20 x 4 cm	16,00	93	12,25€	17,50€
Super Panot 9 pastillas 20 x 20 x 8 cm	9,00	186	29,00€	42,50€
Panot 4 rayas invidentes 20 x 20 x 4 cm	16,00	93	12,25€	17,50€
Super Panot tránsito 4 rayas 20 x 20 x 8 cm	9,00	186	29,00€	42,50€
Panot 16 tacos 20 x 20 x 4 cm	16,00	93	12,25€	17,50€
Super Panot 16 tacos 20 x 20 x 8 cm	9,00	186	29,00€	42,50€
Panot flor 20 x 20 x 4 cm	16,00	93	12,25€	17,50€
Super Panot tránsito flor 20 x 20 x 8 cm	9,00	186	29,00€	42,50€

\* Suplemento por manipulación palet incompleto 35€ / palet. - \* Cargo/abono palet: 19,35€ / ud. - \* Demérito palet, embalaje y flejado: 5,70€ / ud.

**soriguē**

# Urbanización

**Como empresa referente en el sector desde 1966, Sorigué ha desarrollado prefabricados de hormigón que forman parte de las urbanizaciones más emblemáticas del territorio.**

**Sorigué dispone de una amplia gama en bordillos, vados y piezas especiales y su trabajo es sinónimo de calidad, servicio y soluciones adaptadas.**

# Bordillos Serie T

Long. 1.000 mm



## Modelos y dimensiones (en mm)

	T-1	T-1 Autopista	T-2	T-3	T-5
<b>Altura total (A)</b>	200	140	250	280	300
<b>Altura superior (B)</b>	90	90	120	140	190
<b>Altura inferior (C)</b>	120	120	150	170	220
<b>Plinto (D)</b>	110	60	100	130	150
<b>Altura (E)</b>	90	90	150	150	150

Denominación	Capacidad / Palet	Peso	Precio
T1	32 ml/palet	50	10,20€
T1 Autopista	48 ml/palet	36	12,95€
T2	18 ml/palet	82	11,95€
T3	12 ml/palet	104	14,05€
T5	12 ml/palet	148	21,20€

# Bordillo Tipo Americano

ICA Americano Liso

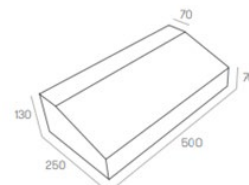

ICA Americano Rayado

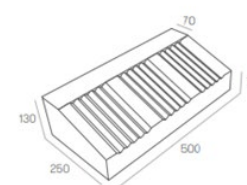

Denominación	Capacidad / palet	Unidad	Peso	Precio
ICA americano liso 25×13×50cm	24 ml/palet	ML	66	20,05€
ICA americano rayado 25×13×50cm	24 ml/palet	ML	66	20,05€

\* Suplemento por manipulación palet incompleto 35€ / palet. - \* Cargo/abono palet: 19,35€ / ud. - \* Demérito palet, embalaje y flejado: 5,70€ / ud.

# Bordillos Remontables

## ICS

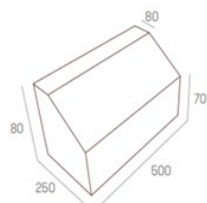

## ICS Nuevo

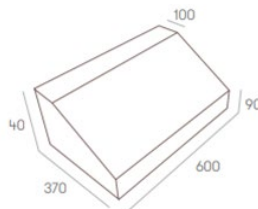

## BR-1

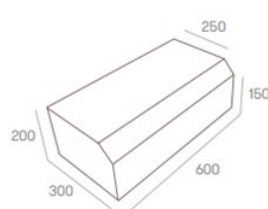

## Vado 15x20

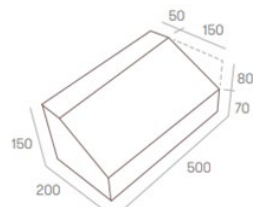

## G-2

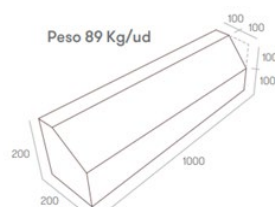

Denominación	Capacidad / Palet	Peso	Precio
ICS 25x28x50cm	12 ml / palet	144	36,10€
ICS Nuevo 37x24x60cm	7,2 ml / palet	169	37,50€
BR - 1 "Renfe" 30x20x50	12 ml / palet	133	38,00€
Bordillo vado 15x20	50 ut / palet	30	24,95€
G-2 20x20x100cm	16 ml/palet	89	36,10€

# Bordillo Jardín

## P-1 Cant rom

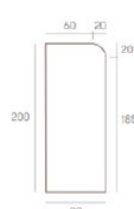

## P-2

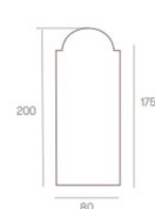

## P-3 Tauló



## Fiol Recto



## G-3

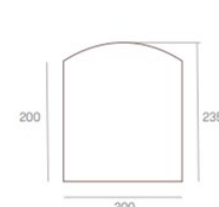

Denominación	Capacidad / palet	Unidad	Peso	Precio
P - 1	48 ml/palet	ML	35	9,75€
P - 2	48 ml/palet	ML	34	9,75€
P - 3	48 ml/palet	ML	36	9,75€
Fiol Recto	48 ml/palet	ML	35	14,15€
G - 3	12 ml/palet	ML	100	38,00€

\* Suplemento por manipulación palet incompleto 35€ / palet. - \* Cargo/abono palet: 19,35€ / ud. - \* Demérito palet, embalaje y flejado: 5,70€ / ud.

# Bordillo Alcorque



## Alcorque Fiol 100

Longitud 910 mm (interior)  
Peso 34 Kg/ud  
Plinto 16,5

## Alcorque Fiol 120

Longitud 1110 mm (interior)  
Peso 41 Kg/ud  
Plinto 16,5

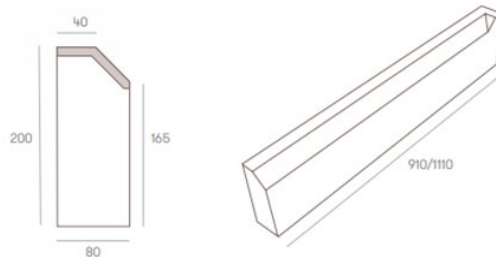

Denominación	Capacidad /palet	Unidad	Peso	Precio
Fiol alcorque 100 x 100	40 ud/palet	UD	34	14,15€
Fiol alcorque 120 x 120	48 ud/palet	UD	42	24,00€

# Rigola

Denominación	Capacidad /palet	Unidad	Peso	Precio
Rigola (20 x 20 x 8 cm) blanca /otros colores	240 ud/palet	UD	8	1,75€
Rigola (20 x 20 x 8 cm) gris	240 ud/palet	UD	8	1,55€
Rigola (30 x 30 x 8 cm) blanca /otros colores	96 ud/palet	UD	17	3,65€
Rigola (30 x 30 x 8 cm) gris	96 ud/palet	UD	17	3,15€



\* Suplemento por manipulación palet incompleto 35€ / palet. - \* Cargo/abono palet: 19,35€ / ud. - \* Demérito palet, embalaje y flejado: 5,70€ / ud.

# Bordillos Especiales ICA

**J-1  
Vila Olímpica**

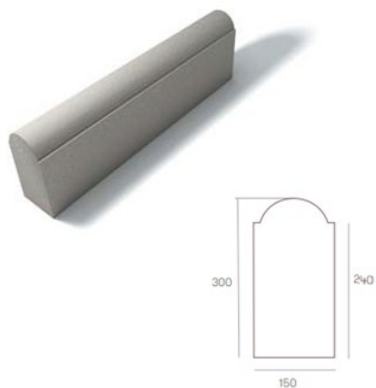

**Z-1  
Vila Olímpica**

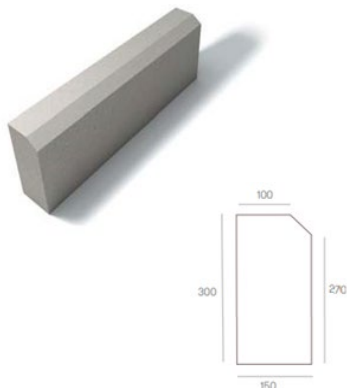

**Bordillo Rigola  
20 X 20**

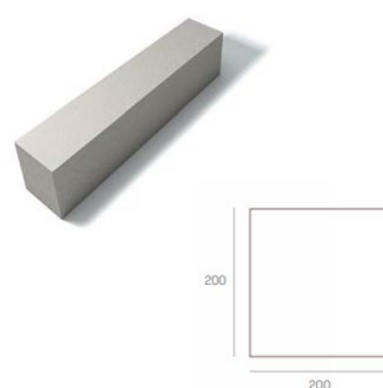

**Bordillo Rigola  
25 X 15**

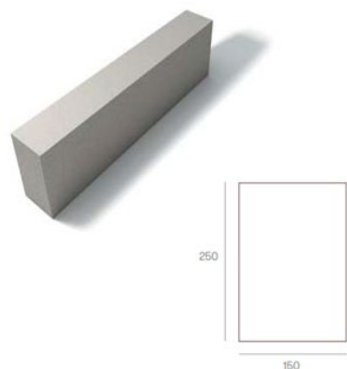

**Bordillo  
Tarragona**



Denominación	Capacidad / Palet	Peso	Precio
J - 1 Vila olímpica	12 ml/palet	100	30,15€
Z - 2 Vila olímpica	12 ml/palet	100	30,15€
Bordillo Rigola 20 x 20	16 ml/palet	96	30,15€
Bordillo Rigola 25 x 15	18 ml/palet	85	23,00€
Tarragona	7,2 ml/palet	100	72,00€

\* Suplemento por manipulación palet incompleto 35€ / palet. - \* Cargo/abono palet: 19,35€ / ud. - \* Demérito palet, embalaje y flejado: 5,70€ / ud.

# Imbornal



**Imbornal T-2**  
Longitud 1000 mm  
Peso 78 Kg/ml

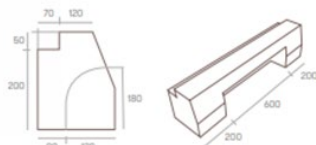

**Imbornal T-3**  
Longitud 1000 mm  
Peso 86 Kg/ml

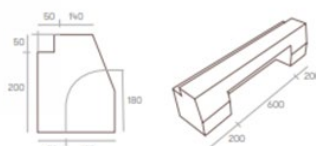

**Imbornal T-5**  
Longitud 1000 mm  
Peso 94 Kg/ml

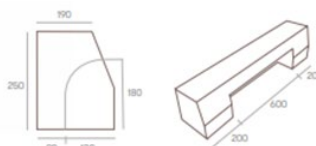

Denominación	Capacidad / Palet	Unidad	Precio
Imbornal T - 2	12 ud / palet	ML	69,50€
Imbornal T - 3	12 ud / palet	ML	79,90€
Imbornal T - 5	12 ud / palet	ML	113,50€



\* Suplemento por manipulación palet incompleto 35€ / palet. - \* Cargo/abono palet: 19,35€ / ud. - \* Demérito palet, embalaje y flejado: 5,70€ / ud.



# Escuadra P

## Escuadra P-1

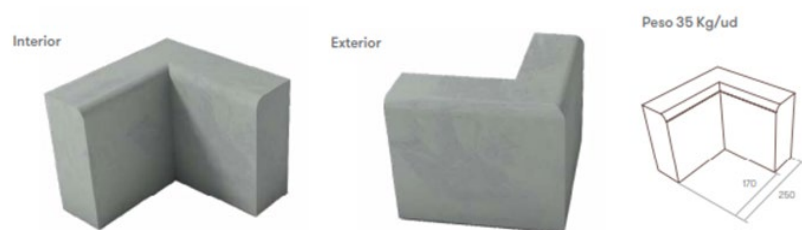

## Escuadra P-2



Denominación	Capacidad / Palet	Unidad	Peso	Precio
Escuadra P-1 (INT / EXT)	62 ud/palet	UD	35	42,00€
Escuadra P-2 (INT / EXT)	62 ud/palet	UD	35	42,00€

# Escuadra T-2, T-3

## Escuadra Bordillo T-2

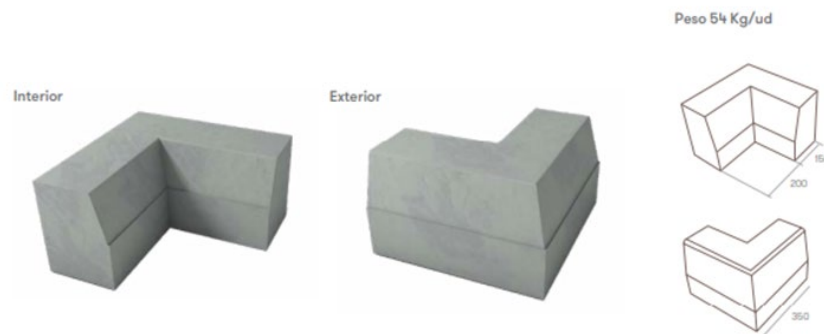

## Escuadra Bordillo T-3

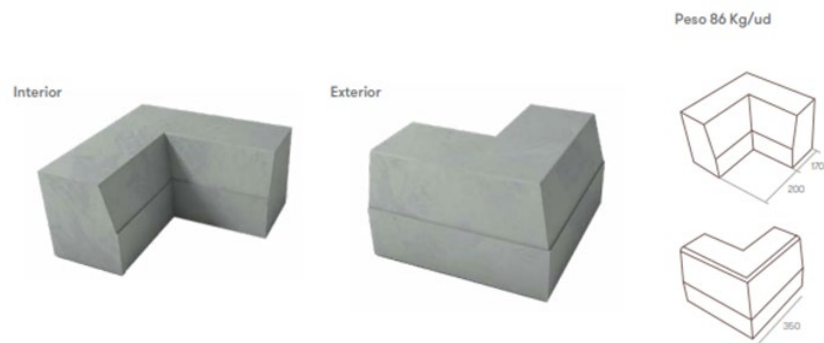

Denominación	Capacidad / Palet	Unidad	Peso	Precio
Escuadra T-2 (INT / EXT)	16 ud/palet	UD	54	69,50€
Escuadra T-3 (INT / EXT)	16 ud/palet	UD	86	79,90€

\* Suplemento por manipulación palet incompleto 35€ / palet. - \* Cargo/abono palet: 19,35€ / ud. - \* Demérito palet, embalaje y flejado: 5,70€ / ud.

# Escuadra T-5

Interior

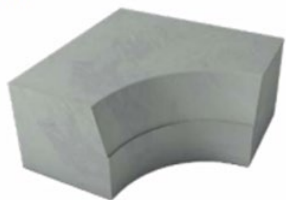

Peso 98 Kg/ud

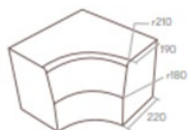

Exterior

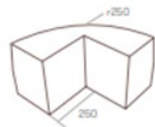

Denominación	Capacidad / Palet	Unidad	Peso	Precio
Escuadra T-5 INTERIOR	9 ud/palet	UD	98	113,50€
Escuadra T-5 EXTERIOR		UD	98	113,50€

# Escuadra Tarragona



Denominación	Capacidad / Palet	Unidad	Peso	Precio
Escuadra Tarragona	8 ud/palet	UD	56	75,00€

\* Suplemento por manipulación palet incompleto 35€ / palet. - \* Cargo/abono palet: 19,35€ / ud. - \* Demérito palet, embalaje y flejado: 5,70€ / ud.

# Curva P-1

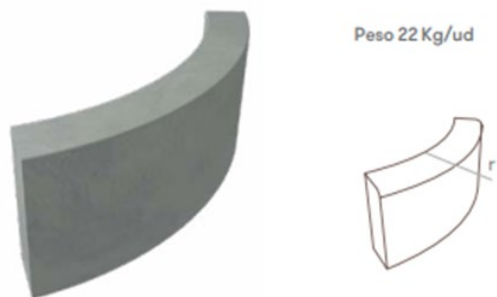

Denominación	Unidad	Peso	Precio
CURVA P1 R=0,50/1/2	UD	22	57,45€



# Curva T-1, T-2, T-5

## Curva interior / invertida / cóncava

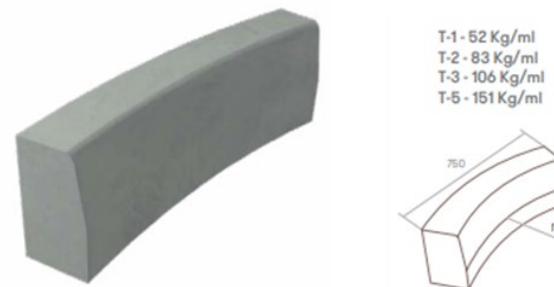

## Curva exterior / estándar / convexa



Denominación	Unidad	Peso	Precio
Curvas interiores/exteriores T-1 desde R=1 hasta R= 8 mts.	ML	52	67,40€
Curvas interiores/exteriores T-2 desde R=1 hasta R= 8 mts.	ML	83	87,80€
Curvas interiores/exteriores T-3 desde R=1 hasta R= 8 mts.	ML	106	98,60€
Curvas interiores/exteriores T-5 desde R=1 hasta R= 8 mts.	ML	151	129,90€

\* Suplemento por manipulación palet incompleto 35€ / palet. - \* Cargo/abono palet: 19,35€ / ud. - \* Demérito palet, embalaje y flejado: 5,70€ / ud.

# Peldaños



## Peldaño Atrium

①



## Peldaño Clasic

②

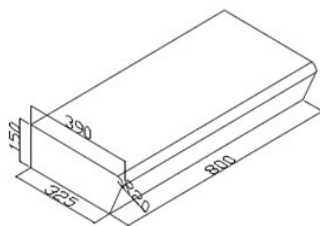

## Peldaño Plaza

③

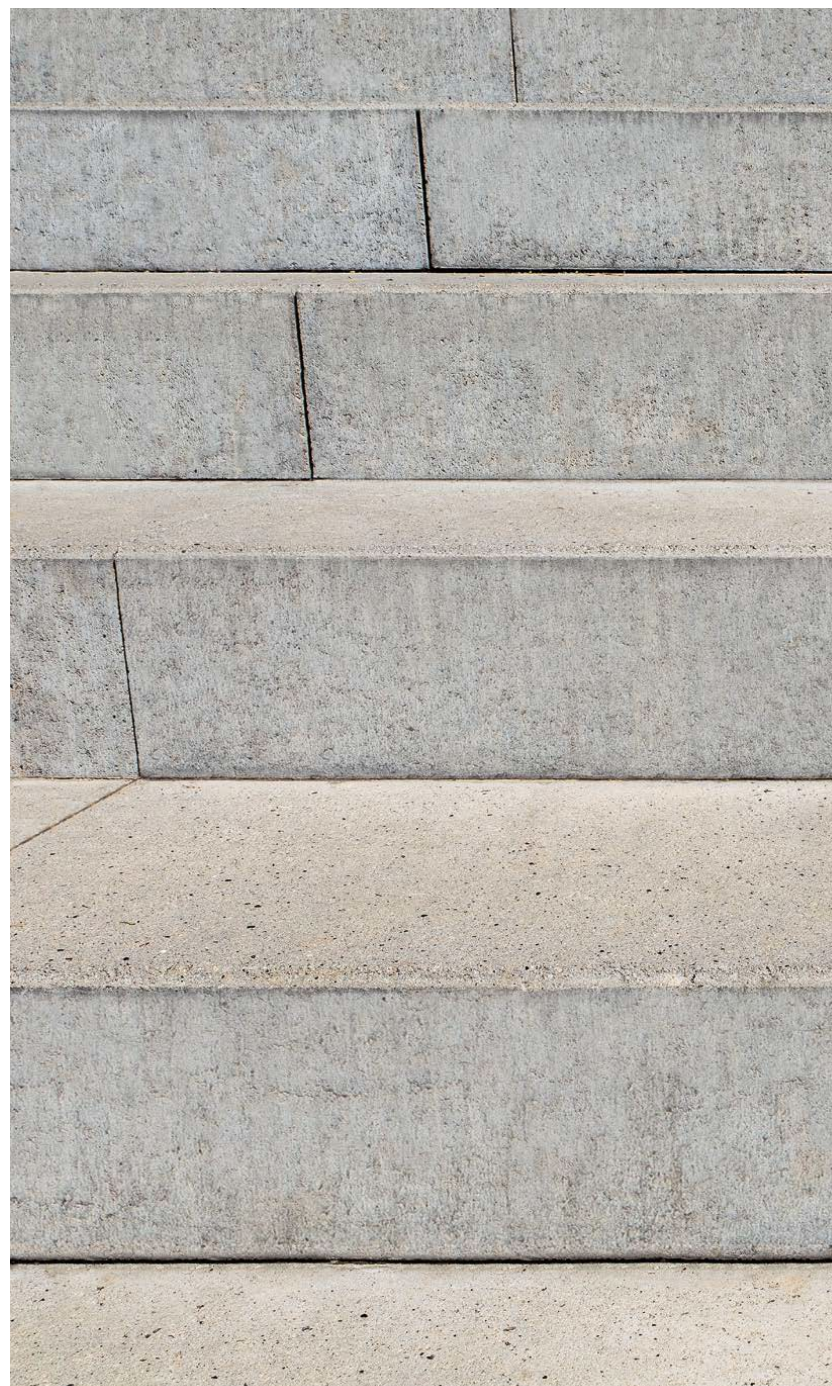
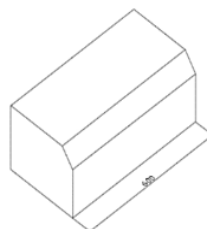
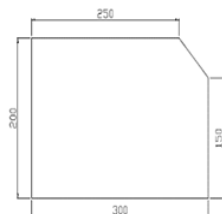

Denominación	Medidas	Unidad	Peso	Precio
1 Atrium	600×400×150	16 ud/palet	86	38,70€/ml
	600×400×200	12 ud/palet	103	61,75€/ml
2 Clasic	800×325×150		112	218,00€/ud
3 Plaza	500×300×200	18 ud/palet	80	19,00€/ud

\* Suplemento por manipulación palet incompleto 35€ / palet. - \* Cargo/abono palet: 19,35€ / ud. - \* Demérito palet, embalaje y flejado: 5,70€ / ud.

# Vados

## Ics Transición Vehículos

Pieza central



Combina con bordillos T-1, T-2, T-3 y T-5

Peso pieza central= 75 Kg/ud  
 Peso T-1= 45 Kg/ud  
 Peso T-2= 52 Kg/ud  
 Peso T-3= 67 Kg/ud  
 Peso T-5= 70 Kg/ud

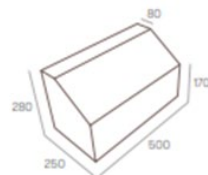

Pieza lateral (derecha e izquierda)

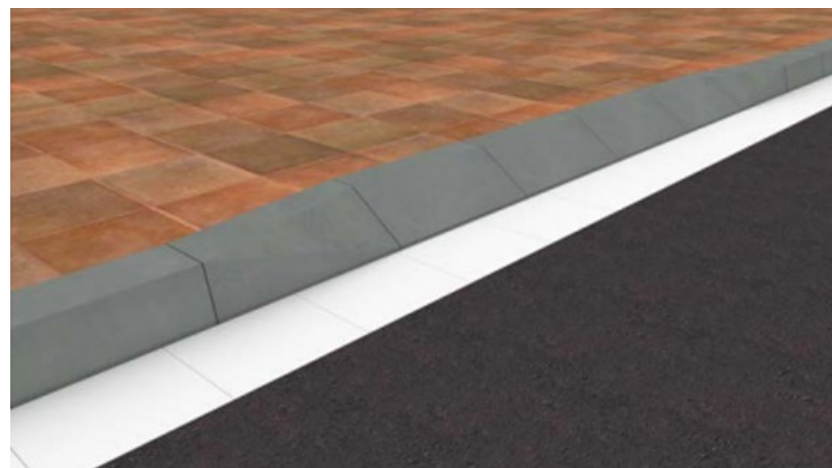
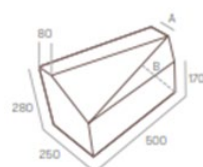

### Cotas (en mm)

Bordillo con el que conecta	(A) Ancho superior	(B) Ancho inferior
T-1	90	120
T-2	120	150
T-3	140	170
T-5	190	220

Denominación	Capacidad/palet	Unidad	Peso	Precio
ICS transición vehículos (central)	12 ml / palet	ML	144	33,25€
ICS transición vehículos (izq./dcha) T-1	12+12 ud/palet	UD	45	49,00€
ICS transición vehículos (izq./dcha) T-2	12+12 ud/palet	UD	52	52,00€
ICS transición vehículos (izq./dcha) T-3	12+12 ud/palet	UD	67	59,75€
ICS transición vehículos (izq./dcha) T-5	12+12 ud/palet	UD	70	64,90€

\* Suplemento por manipulación palet incompleto 35€ / palet. - \* Cargo/abono palet: 19,35€ / ud. - \* Demérito palet, embalaje y flejado: 5,70€ / ud.

# Vados

## Ics Estándar Vehículos

Pieza central



Combina con bordillos  
T-2, T-3 y T-5

Pieza central: Peso 56Kg/ud  
Pieza lateral: Peso 143 Kg/ud

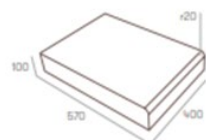

Pieza lateral  
(derecha e izquierda)

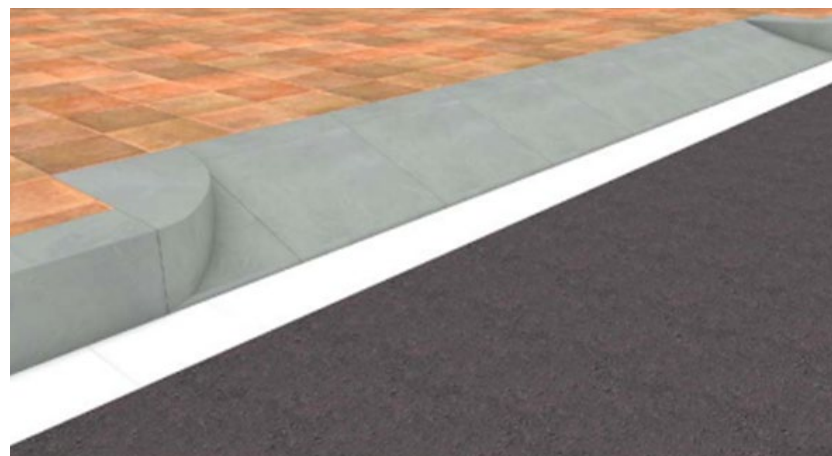
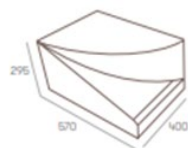

Denominación	Capacidad/ palet	Unidad	Peso	Precio
ICS estándar vehículo Pieza lateral (izq./dcha.)	4+4 ud / palet	UD	143	95,00€
ICS estándar vehículo Pieza central	24 ud / palet	UD	56	34,00€

\* Suplemento por manipulación palet incompleto 35€ / palet. - \* Cargo/abono palet: 19,35€ / ud. - \* Demérito palet, embalaje y flejado: 5,70€ / ud.

# Vados

## Ics Estándar Peatonal

Pieza central 1a fila



Combina con bordillos T-2, T-3 y T-5

Pieza central 1a fila:  
Peso 56Kg/ud

Pieza lateral 1a fila:  
Peso 143 Kg/ud

Pieza lateral 2a fila:  
Peso 112 Kg/ud

Pieza central 2a fila:  
Peso 56Kg/ud

Pieza lateral 1a fila (derecha e izquierda)

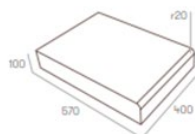

Pieza lateral 2a fila (derecha e izquierda)

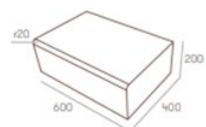
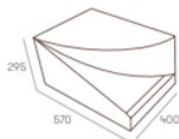

Pieza central 2a fila

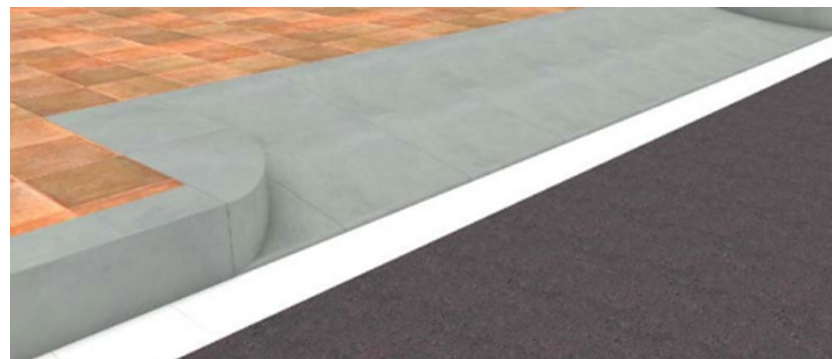
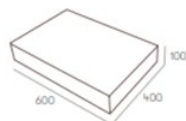
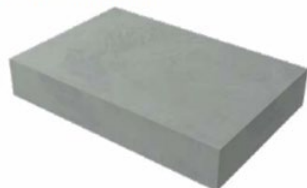

Denominación	Capacidad/ palet	Unidad	Peso	Precio
ICS estándar peatonal 1a. fila	4+4 ud / palet	UD	143	95,00€
ICS estándar peatonal (central) 1a. fila	24 ud / palet	UD	56	34,00€
ICS estándar peatonal (lateral) 2 a. fila	12 ud / palet	UD	112	61,75€
ICS estándar peatonal (central) 2 a. fila	24 ud/ palet	UD	56	34,00€
Baden ics central táctil 60x40x7	40 ud / palet	UD	37	34,00€

\* Suplemento por manipulación palet incompleto 35€ / palet. - \* Cargo/abono palet: 19,35€ / ud. - \* Demérito palet, embalaje y flejado: 5,70€ / ud.

# Vados

## Ics Nuevo Vehículos

Pieza central

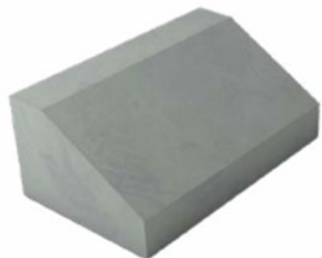

Pieza lateral  
(derecha e izquierda)



Combina con bordillos  
T-2, T-3 y T-5

Pieza central: Peso 90 Kg/ud  
Pieza lateral: Peso 67 Kg/ud

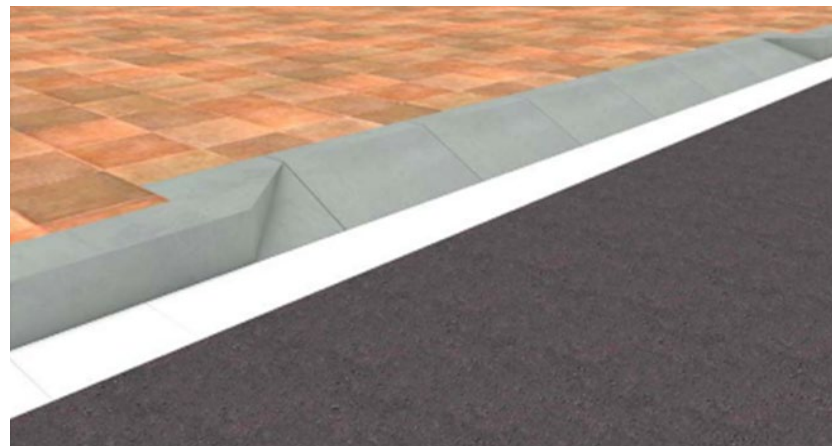
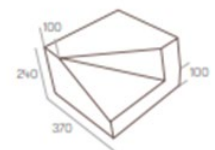
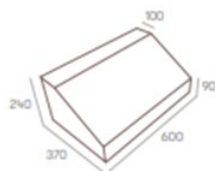

Denominación	Capacidad/ palet	Unidad	Peso	Precio
ICS nuevo vehículos [lateral]	6+6 ud/palet	UD	67	63,50€
ICS nuevo vehículos [central]	7,2 ml/palet	ML	169	37,00€

\* Suplemento por manipulación palet incompleto 35€ / palet. - \* Cargo/abono palet: 19,35€ / ud. - \* Demérito palet, embalaje y flejado: 5,70€ / ud.



# Vados

## Sabadell (Vehículos / Peatonal)

Pieza central



Pieza lateral  
(derecha e izquierda)



Vado Sabadell  
(vehículos y peatonal)

Combina con bordillo T-5

Pieza central: Peso 152 Kg/ud  
Pieza lateral: Peso 120 Kg/ud

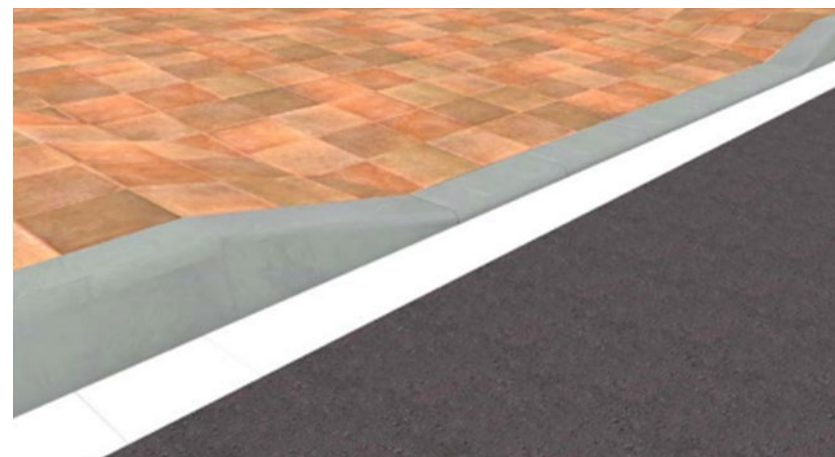
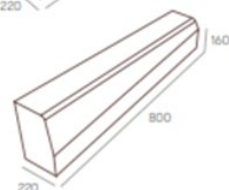
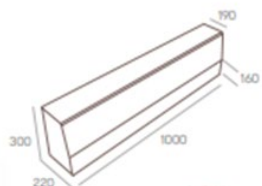

Cotas (en mm)

Bordillo con el que conecta	(A) Ancho superior	(B) Ancho inferior
T-5	190	220

Denominación	Capacidad/ palet	Unidad	Peso	Precio
Sabadell veh / peat (izq./dcha.)	10 ud/palet	UD	120	105,50€
Sabadell veh / peat (central)	12 ud/palet	UD	152	20,50€

\* Suplemento por manipulación palet incompleto 35€ / palet. - \* Cargo/abono palet: 19,35€ / ud. - \* Demérito palet, embalaje y flejado: 5,70€ / ud.

# Vados

## Manresa

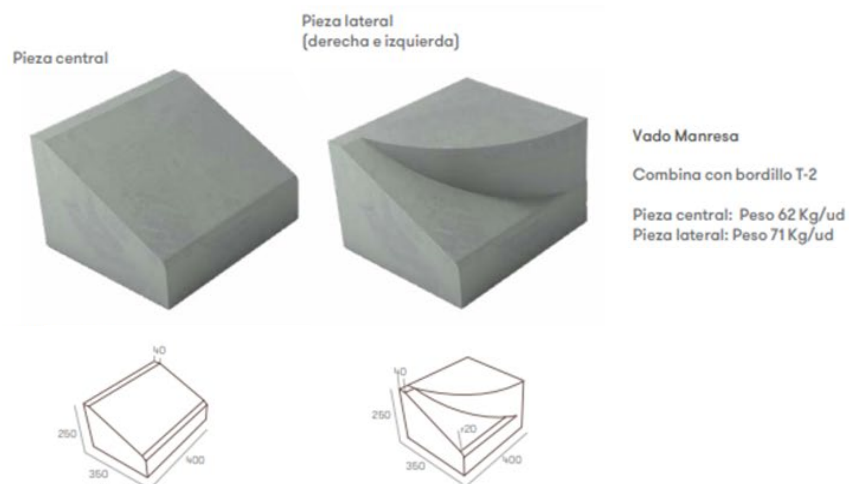

Denominación	Capacidad/palet	Unidad	Peso	Precio
Manresa (izq./dcha.)	6+6 ud/palet	UD	71	61,50€
Manresa (central)	18 ud/palet	UD	62	58,30€

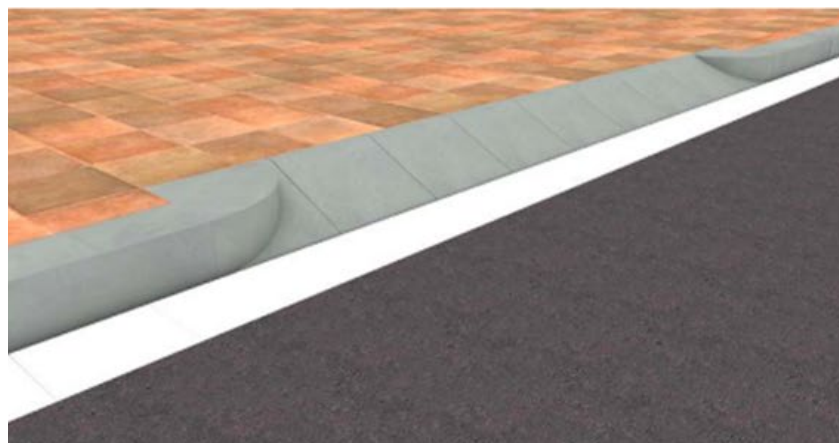

## Barcelona

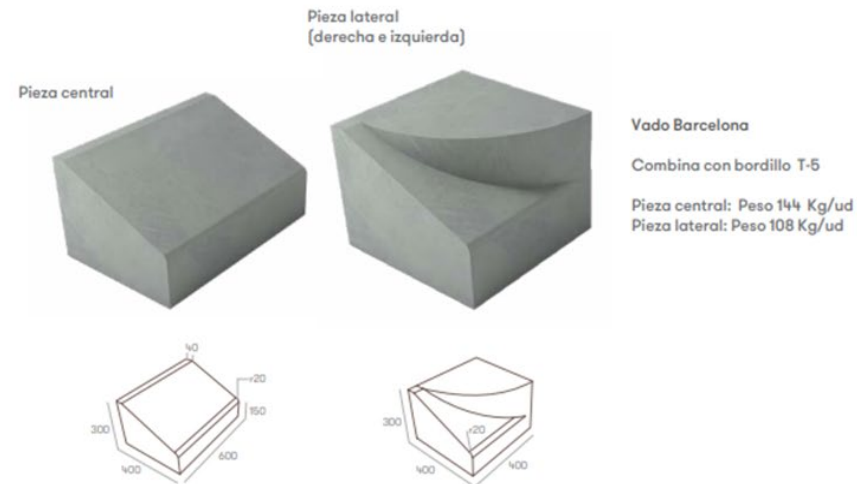

Denominación	Capacidad/palet	Unidad	Peso	Precio
Barcelona (izq./dcha.)	6+6 ud/palet	UD	108	102,50€
Barcelona (central)	9 ud/palet	UD	144	103,25€

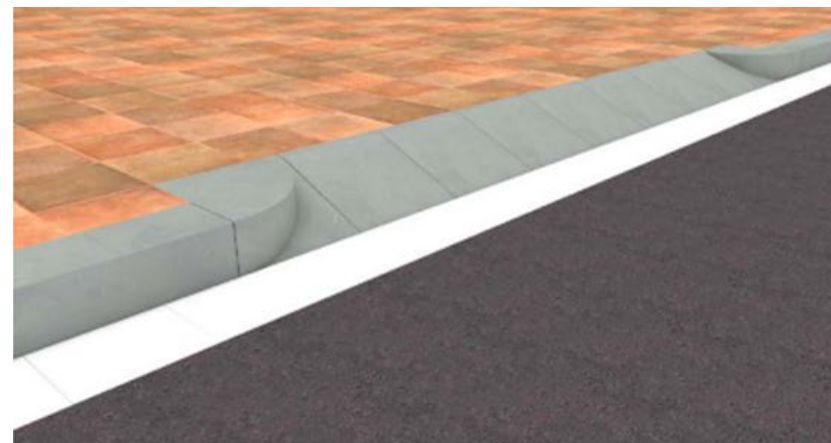

\* Suplemento por manipulación palet incompleto 35€ / palet. - \* Cargo/abono palet: 19,35€ / ud. - \* Demérito palet, embalaje y flejado: 5,70€ / ud.

# Vados

## Serie H

Pieza central



Combina con bordillos T-3 y T-5

Pieza central:  
Serie T-3 H Peso 77 Kg/ud  
Serie T-5 H Peso 100 Kg/ud

Pieza lateral:  
Sabadell Serie H  
Peso 77 Kg/ud  
Martorell Serie H  
Peso 61 Kg/ud

Pieza lateral  
(derecha e izquierda)



Pieza izquierda

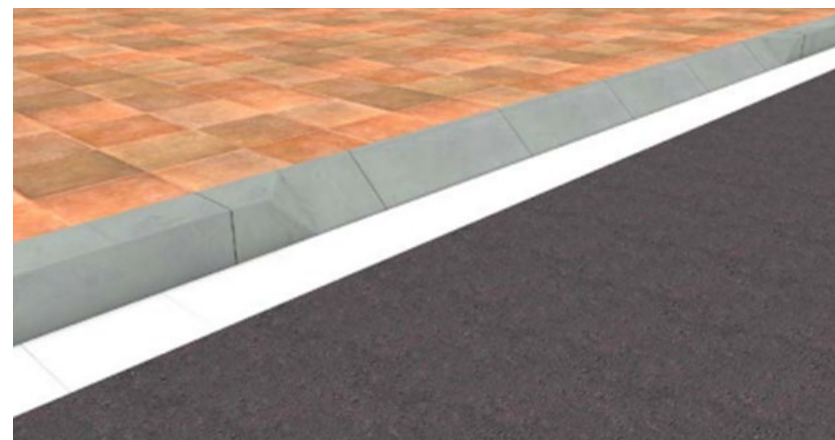
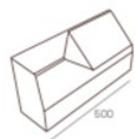
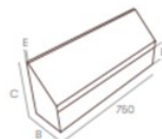

### Modelos y dimensiones (en mm)

Modelo	Dimensiones pieza central			
	(B) Anchura interior	(C) Altura total	(D) Plinto	(E)
Serie T-3H	170	280	140	15
Serie T-5H	220	300	160	30

Denominación	Capacidad/ palet	Unidad	Peso	Precio
Serie T-3 H vehículos (izq./dcha.)	12+12 ud/palet	UD	61	60,30€
Serie T-3 H vehículos (central)	18 ud/palet	UD	77	62,90€
Serie T-5 H vehículos (izq./dcha.)	12+12 ud/palet	UD	77	75,90€
Serie T-5 H vehículos (central)	15 ud/palet	UD	100	78,50€

\* Suplemento por manipulación palet incompleto 35€ / palet. - \* Cargo/abono palet: 19,35€ / ud. - \* Demérito palet, embalaje y flejado: 5,70€ / ud.

# Pasos peatonales elevados

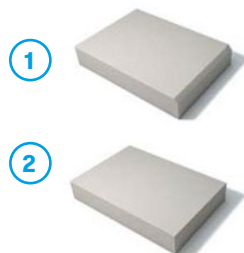

Denominación	Capacidad	Peso	Precio
1 Modelo de pieza para la formación de la rampa	24	56	34,00€
2 Modelo de pieza para la plataforma superior	24	56	34,00€

# Acabados especiales

Suplemento bordillo color	<b>CONSULTAR</b>
Suplemento acabado granallado	
Suplemento bordillo alta resistencia (R-5 MPa)	



\* Suplemento por manipulación palet incompleto 35€ / palet. - \* Cargo/abono palet: 19,35€ / ud. - \* Demérito palet, embalaje y flejado: 5,70€ / ud.



soriguē

# Saneamiento

En el complejo industrial La Plana del Corb que Sorigué posee en Balaguer, Lleida, se ubica una fábrica específica de prefabricados de saneamiento equipada con la mejor maquinaria del sector para ofrecer las mejores soluciones en marcos, tuberías campana, tuberías cilíndricas, tubos hinca y complementos.

# Pozos de registro de hormigón armado

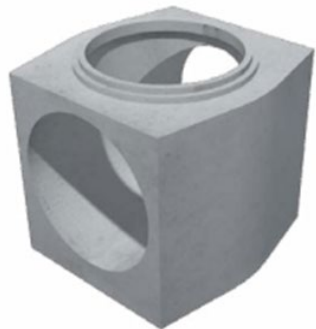

Bases de pozo 1200 x 1200  
hormigón armado

Peso 2930 Kg

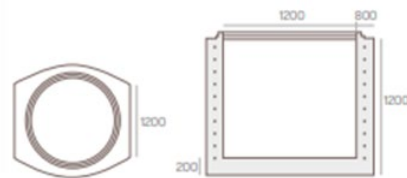

[CONSULTAR PRECIO](#)



Bases de pozo 1500 x 2000  
y 1500 x 2400  
hormigón armado

1500 x 2000  
Peso Kg L= 2000

1500 x 2400  
Peso Kg L= 2400

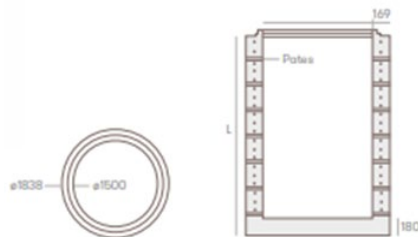

[CONSULTAR PRECIO](#)

# Cono de reducción para pozos de registro de hormigón armado



Conos de reducción para pozos  
de registro de hormigón armado

Peso 1134 Kg

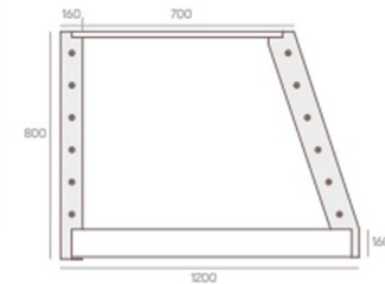

[CONSULTAR PRECIO](#)

# Anillos para pozos de registro de hormigón armado

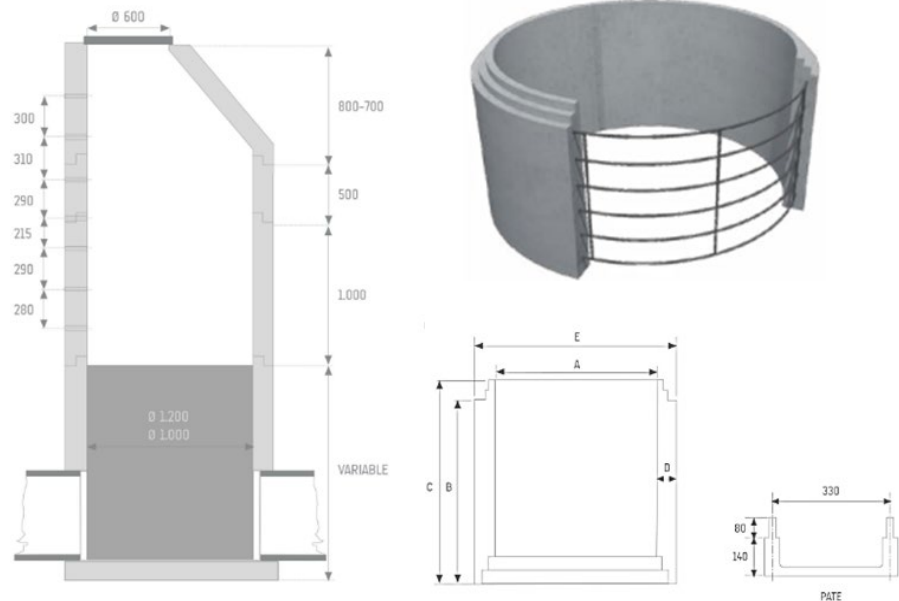

A	TOL.	B	TOL.	C	D	TOL.	E	SERIE	PESOS Kg	MANIPULACIÓN
Ø INTERIOR	DIM.	ALTURA ÚTIL	DIM.	ALTURA TOTAL	ESPESOR PARED	DIM.	Ø EXTERIOR	RESISTENCIA KN/m2	UNIDAD*	
1.000	±12	300	±4.5	421	120	-6	1.240	R (60)	340	Bulón
1.000	±12	500	±7.5	621	120	-6	1.240	R (60)	600	Bulón
1.000	±12	1.000	±15	1.121	120	-6	1.240	R (60)	1.200	Bulón
1.200	±14	300	±4.5	425	160	-8	1.520	R (60)	520	Bulón
1.200	±14	500	±7.5	625	160	-8	1.520	R (60)	860	Bulón
1.200	±14	1.000	±15	1.125	160	-8	1.520	R (60)	1.936	Bulón

\* Pesos aproximados. Medidas en mm

[CONSULTAR PRECIO](#)

# Tapas para pozos de registro de hormigón armado

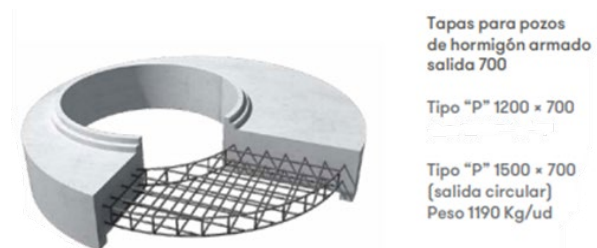

Tapas para pozos de hormigón armado salida 700

Tipo "P" 1200 x 700

Tipo "P" 1500 x 700 (salida circular)  
Peso 1190 Kg/ud

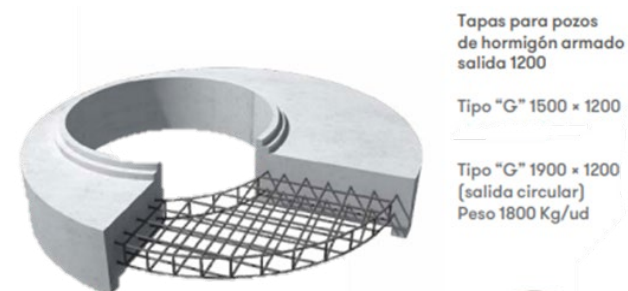
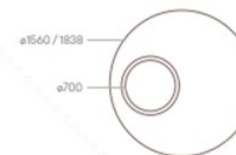

Tapas para pozos de hormigón armado salida 1200

Tipo "G" 1500 x 1200

Tipo "G" 1900 x 1200 (salida circular)  
Peso 1800 Kg/ud

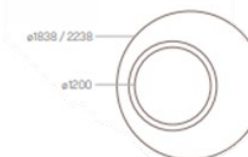

[CONSULTAR PRECIO](#)

\* Suplemento por manipulación palet incompleto 35€ / palet. - \* Cargo/abono palet: 19,35€ / ud. - \* Demérito palet, embalaje y flejado: 5,70€ / ud.

# Bajantes y cunetas

## BAJANTE C - 1

Peso 305Kg / ud  
4 ud / palet

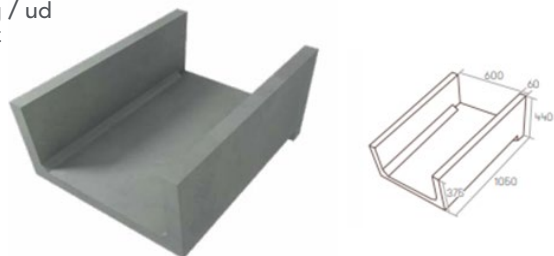

## BAJANTE C - 2

Peso 76Kg / ud  
10 ud / palet

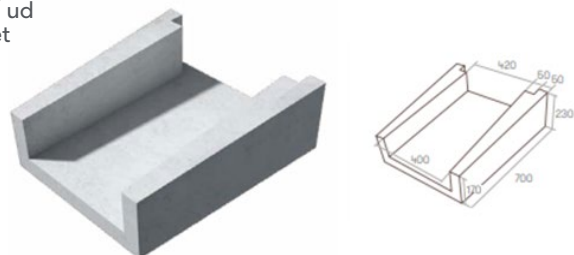

## BAJANTE C - 3

Peso 33Kg / ud  
24ud / palet

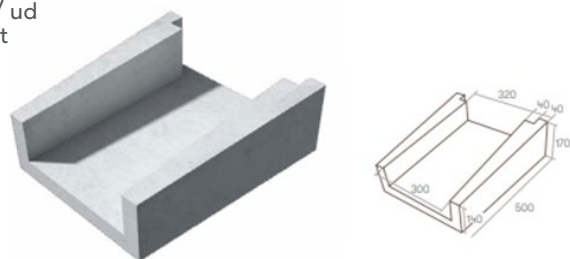

## CUNETA C-13 30×13×60 "V" / CONCAVA

Peso 74Kg / ml  
21,60ml / palet

CUNETA C-13 30×10×50  
CONCAVA  
Peso 70Kg / ml

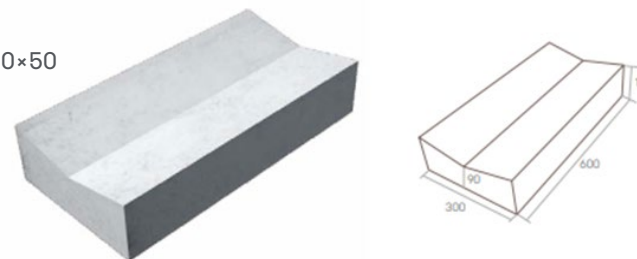

## CUNETA C-15 40×13×50

Peso 112Kg / ml  
14ml / palet

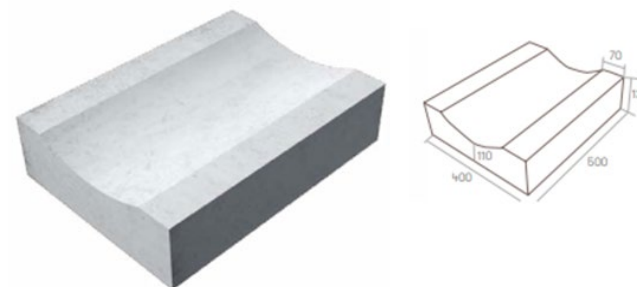

Denominación	Precio
Bajante C - 1	71,55€/ud
Bajante C - 2	46,90€/ud
Bajante C - 3	42,30€/ud
Cuneta C-13 (30 × 13 × 60 "V")	42,50€/ml
Cuneta C-13 (30 × 10 × 50 Cóncava)	42,50€/ml
Cuneta C-15 (40 × 13 × 50)	49,75€/ml

\*Pesos aproximados. Medidas en mm.

\* Suplemento por manipulación palet incompleto 35€ / palet. - \* Cargo/abono palet: 19,35€ / ud. - \* Demérito palet, embalaje y flejado: 5,70€ / ud.



# Arquetas



Denominación	Peso	Precio
Arqueta 30×30×33 (INT) HM con fondo	55	34,85€
Arqueta 30×30×33 (INT) HM sin fondo	46	33,55€
Arqueta 42×42×45 (INT) 50×50 (EXT) HM con fondo	55	47,85€
Arqueta 42×42×45 (INT) 50×50 (EXT) HM sin fondo	46	44,75€
Arqueta 50×50 (INT) 60×60 (EXT) HM con fondo	150	55,10€
Arqueta 50×50 (INT) 60×60 (EXT) HM sin fondo	125	50,85€
Arqueta 60×60/65 (INT) 70×70 (EXT) HM con fondo	250	60,15€
Arqueta 60×60/65 (INT) 70×70 (EXT) HM sin fondo	250	56,90€
Arqueta 70×70×50 HM sin fondo	360	102,75€
Arqueta 70×70×75 (INT) HM con fondo	340	93,65€
Arqueta 70×70×75 (INT) HM sin fondo	280	87,70€
Arqueta 80×80/80 (INT) HM con fondo	560	184,45€
Arqueta 80×80/80 (INT) HM sin fondo	454	175,55€
Arqueta 1000×1000/500 HM sin fondo	540	213,20€
Arqueta 1.000×1.000/1.000 (INT) HM con fondo	1.080	426,05€
Arqueta 1.000×1.000/1.000 (INT) HM sin fondo	910	387,85€
Arqueta 1.200×1.200/500 (INT) HM sin fondo	667	241,30€
Arqueta 1.200×1.200/1.000 (INT) HM con fondo	1.367	527,75€
Arqueta 1.200×1.200/1.000 (INT) HM sin fondo	1.050	438,70€

# Tapas

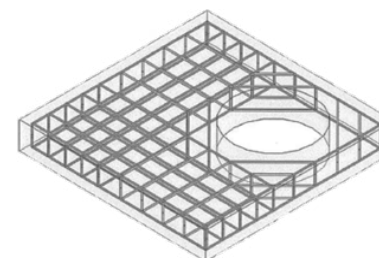

Denominación	Peso	Precio
Tapa HA 1200×1200/100 simple ciega	345	335,95€
Tapa HA 1200×1200/200 (Salida 700×700)	460	620,50€
Tapa HA 1200×1200/200 (Salida Ø 600)	460	620,50€
Tapa HA 1400×1400/200 (Salida 700×700)	720	715,20€
Tapa HA 1400×1400/200 (Salida Ø 600)	720	715,20€

# Imbornales

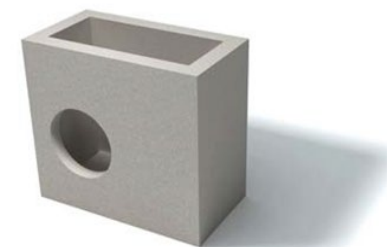

Denominación	Peso	Precio
Imbornal 55×30/70 HM (con fondo)	272	72,60€
Imbornal 70×30×65 HM con fondo	335	57,10€
Supl. Imbornal 70×30×65 HM sin fondo	285	55,80€
Imbornal 70×30×100 HM con fondo	530	71,20€
Imbornal 70×30×100 HM sin fondo	580	69,25€

\*Pesos aproximados. Medidas en cm.

\* Suplemento por manipulación palet incompleto 35€ / palet. - \* Cargo/abono palet: 19,35€ / ud. - \* Demérito palet, embalaje y flejado: 5,70€ / ud.

# Pozos de hormigón en masa

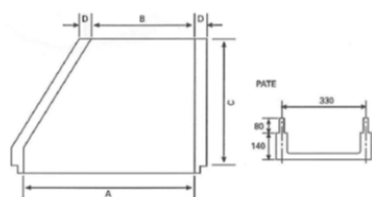
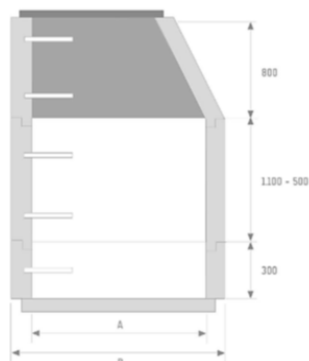

Denominación	Unidad	Peso Kg/ud.	Precio ud.
cono 80×60×40 hm	ud.	215	94,80€
cono 80 × 60 × 80 hm	ud.	390	94,80€
anillo 80 × 30 hm	ud.	146	51,05€
anillo 80 × 50 hm	ud.	230	61,75€
anillo 80 × 110 hm	ud.	540	117,50€
cono 100 × 60 × 80 hm	ud.	513	143,95€
anillo 100 × 30 hm	ud.	250	79,25€
anillo 100 × 50 hm	ud.	360	101,40€
anillo 100 × 110 hm	ud.	870	146,75€
cono 120 × 60 × 80 hm	ud.	660	248,25€
anillo 120 × 30 hm	ud.	316	121,30€
anillo 120 × 50 hm	ud.	520	157,20€
anillo 120 × 110 hm	ud.	1.160	238,80€

\* Suplemento por manipulación palet incompleto 35€ / palet. - \* Cargo/abono palet: 19,35€ / ud. - \* Demérito palet, embalaje y flejado: 5,70€ / ud.

# Barreras New Jersey

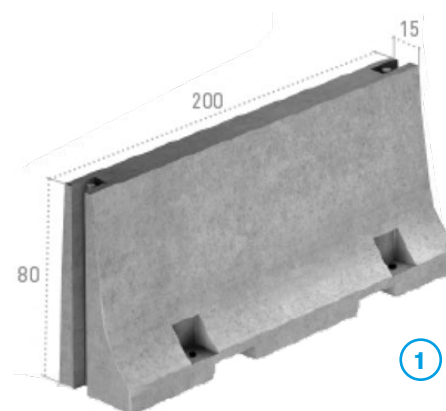

1

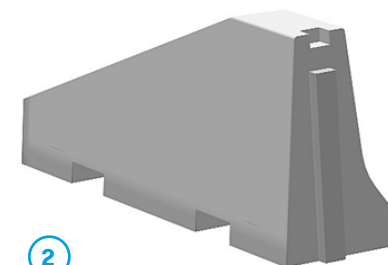

2

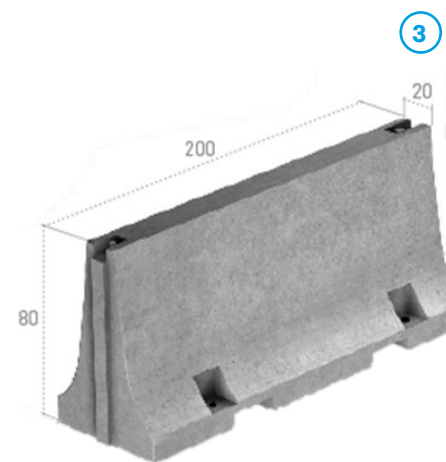

3

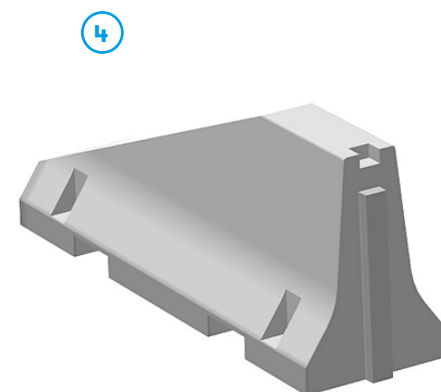

4

\*Pesos aproximados.

Denominación	Peso	Precio
1 Barrera New Jersey 1 cara	976Kgs/ud	69,75€/ml
2 Terminal New Jersey 1 caras	850 Kgs/ud	149,75€/ud
3 Barrera New Jersey 2 cara	1.140 Kgs/ud	81,20€/ml
4 Terminal New Jersey 2 caras	900 Kgs/ud	153,25€/ud

# Tubos vibro prensados de hormigón en masa



A Interior	B Long. Total	D Espesor	E Ø Exterior	Peso Kg. /ud.	Precio ml.
200	1.100	200	250	49	19,25€
300	1.100	410	380	108	24,25€
400	1.100	510	500	165	31,15€
500	1.100	450	590	245	43,05€
600	1.100	550	710	325	61,10€
800	1.100	710	940	550	99,20€
1.000	1.100	930	1.186	899	146,65€
1.200	1.100	1.000	1.380	1.159,40	230,85€

\*Pesos aproximados. Medidas en mm.



# Condiciones generales

soriguē

Estos precios no incluyen IVA.  
Precios válidos sobre camión en nuestra factoría.  
Transporte no incluido.  
Esta tarifa anula las anteriores.  
Certificación por acopios en tubería de hinca.

Sant Andreu de la Barca, 2025

Concepto	Precio
Cargo / Abono palet	19,35€
Demérito y flejado	5,70€
Manipulación palet incompleto	35,00€
Listón de madera para bordillos especiales	1,00€
Horas espera camión	89,00€
Suplemento de reparto en obra por cada punto de descarga extra (precio / Hr.)	89,00€
Cargo palet sin retorno	23,50€
Suplemento de taladro en pozos y tubos	195,00€
Suplemento de corte de tubo	195,00€
Cargo / Abono Cabirón	35,00€
Depreciación Cabirón	12,00€
Gancho colocación DEHA 10 TM	925,00€
Gancho colocación DEHA 20 TM	1.250,00€
Demerito gancho colocación DEHA 10 / 20 Tn.	320,00€
Gancho colocación Tubo Campana	3.900,00€
Demerito gancho colocación Tubo Campana	610,00€
Sufridera madera Tubos Hinca	42,00€

Cr. Torre Bovera,44  
Tel. 936 828 530 · Fax. 936 532 129  
08740 Sant Andreu de Barca · Barcelona  
Carretera C-12, km 162  
Tel. 973 457 005 · Fax. 973 457 006  
25600 Balaguer

[www.sorigue.com](http://www.sorigue.com)

# soriguē

CREAR · COMPARTIR · PERDURAR